

listen



school things

name:

Listen and number.

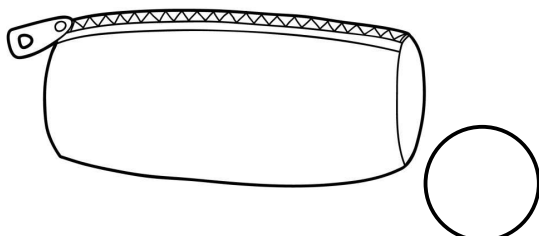
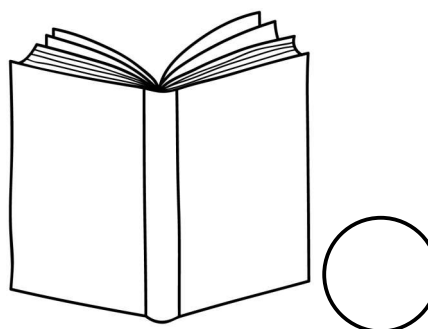
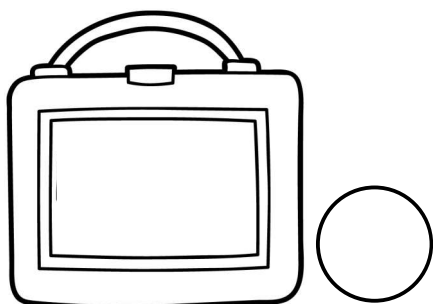
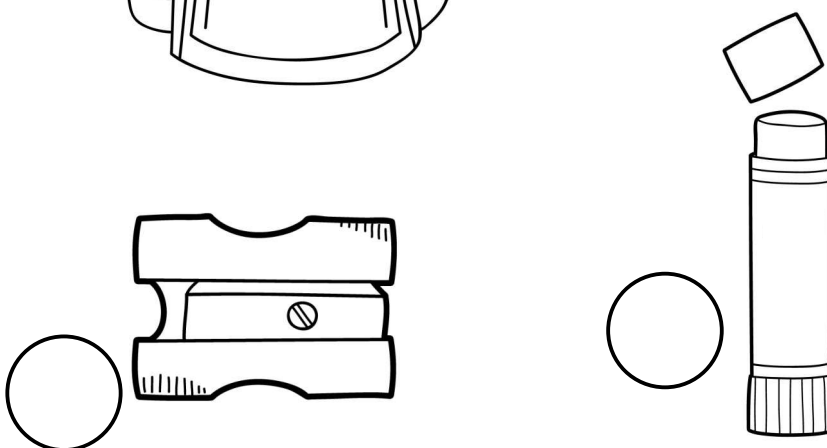
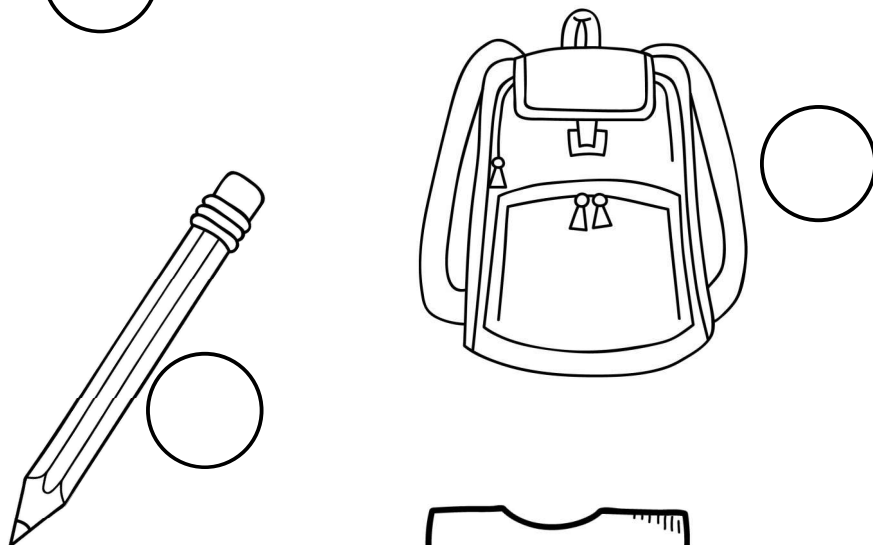
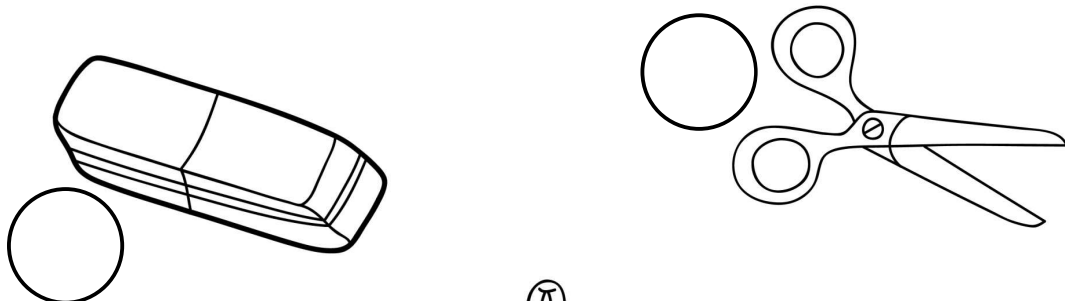

listen



school things

name:

1. Listen and match.

Bob

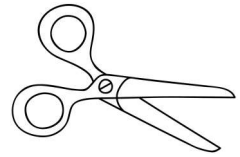
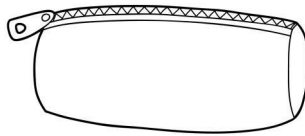
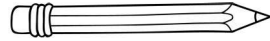
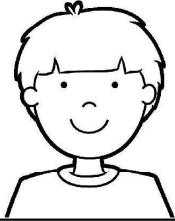

Nick

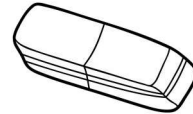
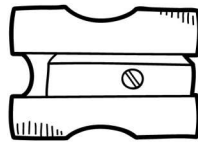
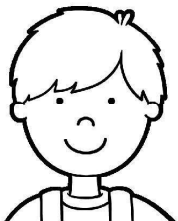

Emma

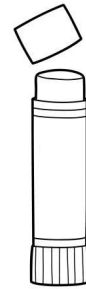
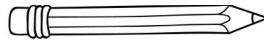
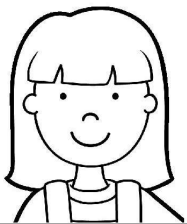

Kim

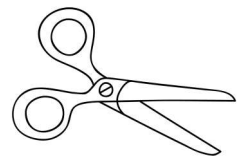
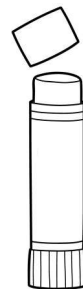
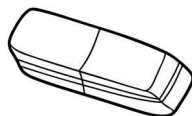
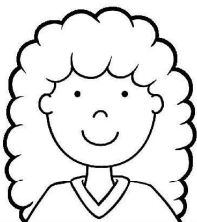

Beispieltext:

Bob has got a pencil, a glue and a schoolbag.

Nick has got a pencil case, a pencil and a pair of scissors.

Emma has got a rubber, a glue and a pair of scissors.

Kim has got a sharpener, a rubber and a schoolbag.

Interview



school things

name:



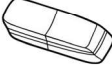

1. Interview

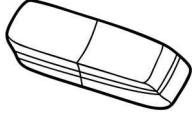

Have you got
a  ?

Yes, I have. ✓
No, I haven't. ✗

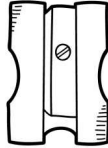

name					

Speak



school things

name: _____

1. Colour your school things.

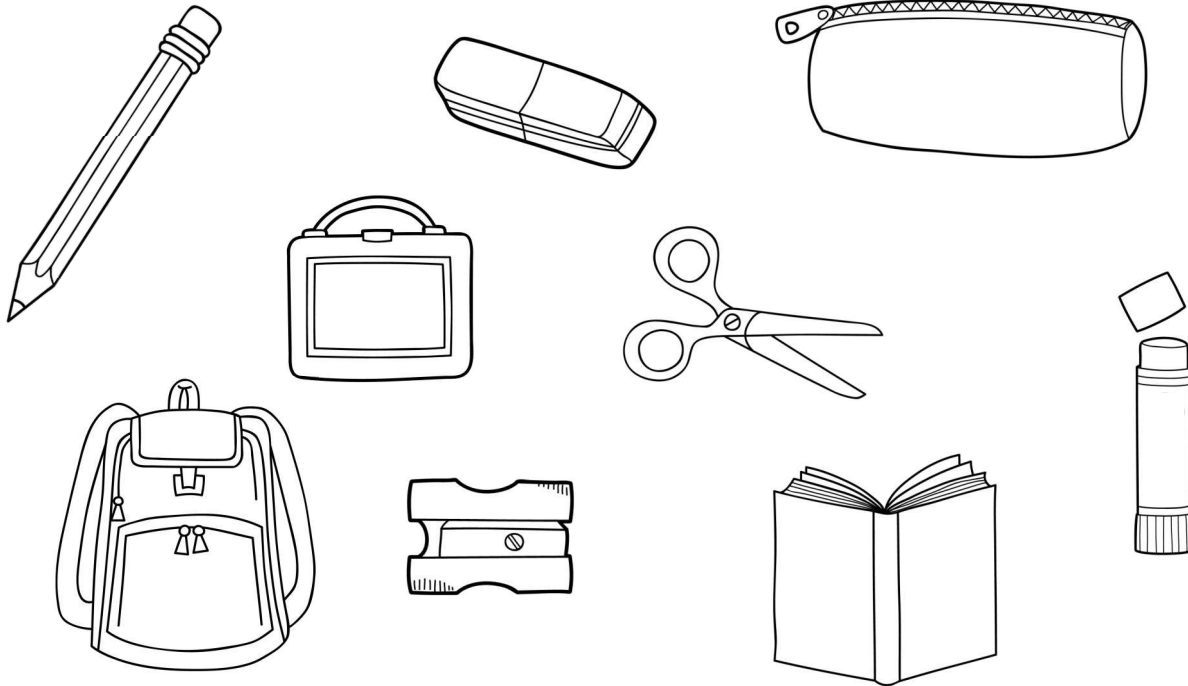

2. Do a partner dictation.

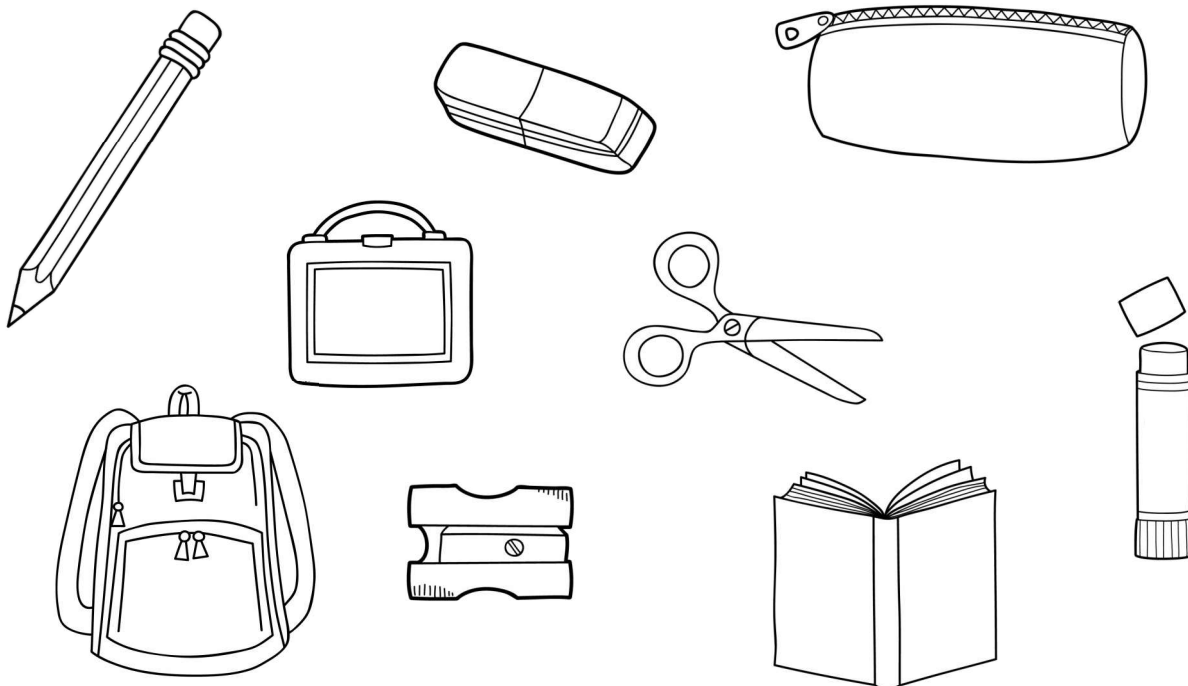

Speak



school things

name: _____

1. Talk and guess.

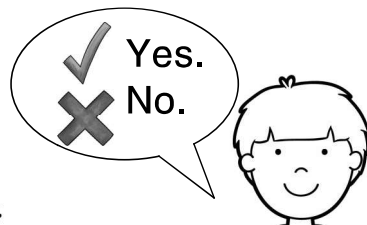
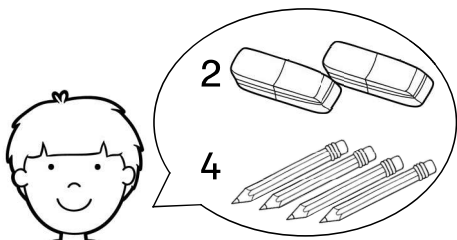

1

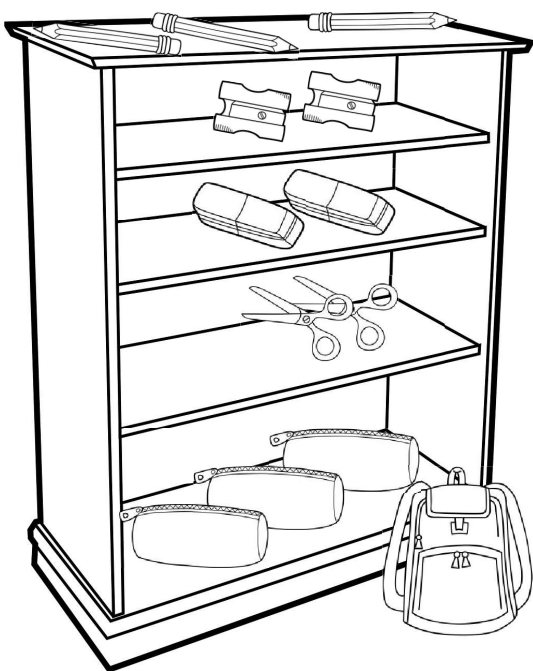

2

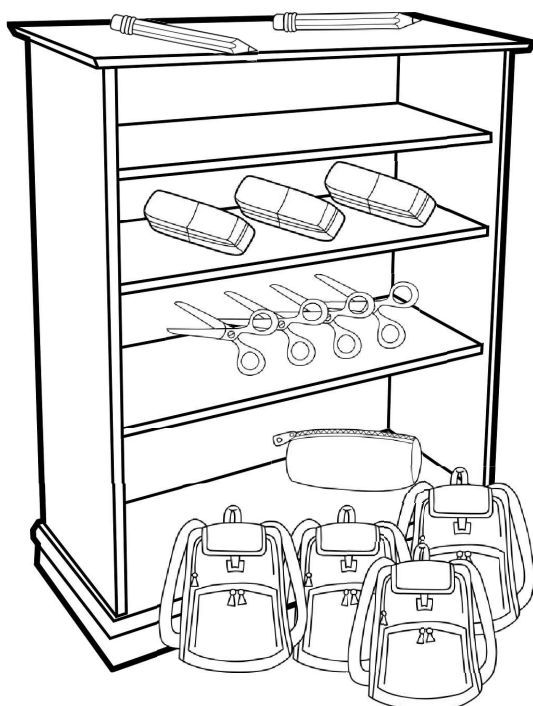

3

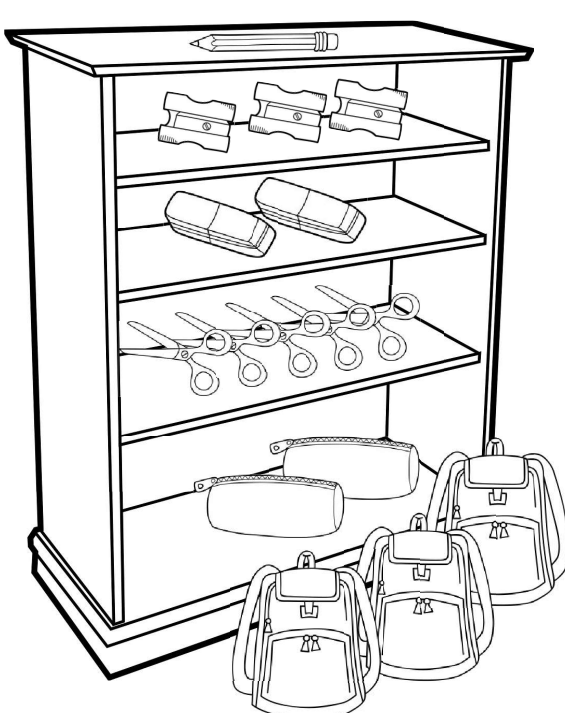

4

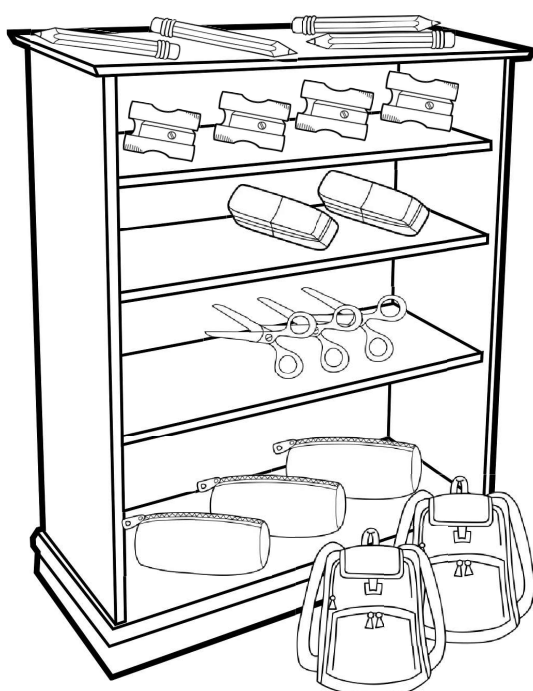

read



school things

name: _____

1. Read and draw lines.

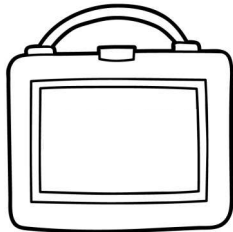
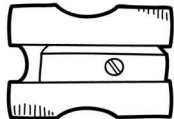
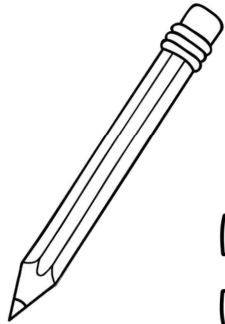

scissors

book

pencil case

pencil

lunchbox

rubber

sharpener

glue

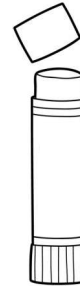
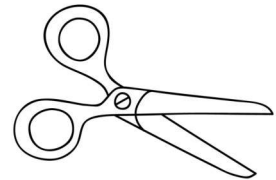
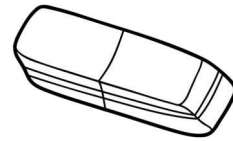
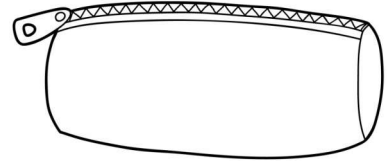

2. Read and find the hidden words.

B	O	J	C	F	F	K	R	U	B	B	E	R
Q	S	G	J	J	G	G	C	F	P	U	Q	Y
P	C	Y	L	U	N	C	H	B	O	X	B	C
B	I	Q	Q	B	R	K	Z	G	R	V	O	P
S	S	M	L	X	M	N	U	K	Y	W	T	E
C	S	J	R	Z	P	E	N	C	I	L	B	N
H	O	M	Z	B	V	S	M	G	K	C	Z	C
O	R	J	R	K	W	L	V	Y	S	Q	B	I
O	S	X	O	L	J	P	W	K	Z	F	W	L
L	L	L	O	Q	Q	B	O	O	K	K	V	C
B	P	A	P	G	G	M	Q	J	C	K	Z	A
A	C	O	N	K	W	G	L	U	E	X	B	S
G	R	S	H	A	R	P	E	N	E	R	G	E

scissors	↓
book	→
pencil case	↓
pencil	→
lunchbox	→
rubber	→
sharpener	→
glue	→
schoolbag	↓

3

scissors

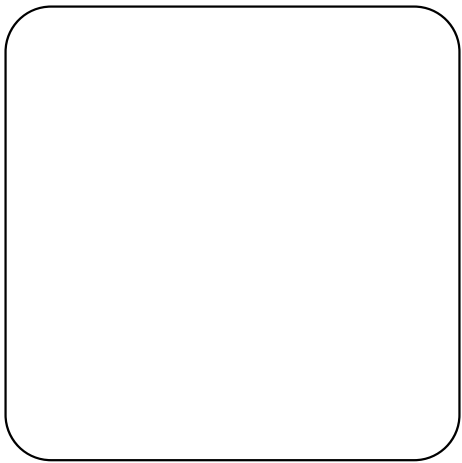

4

rubber

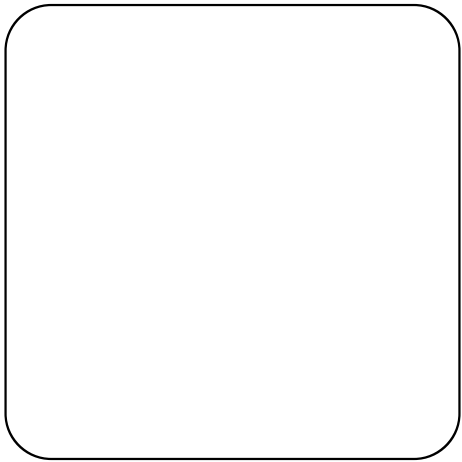

5

sharpener

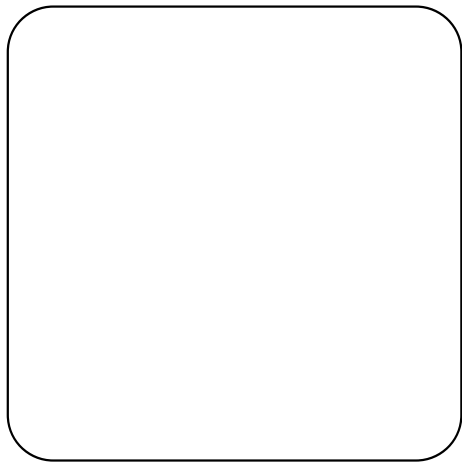

6

pencil case

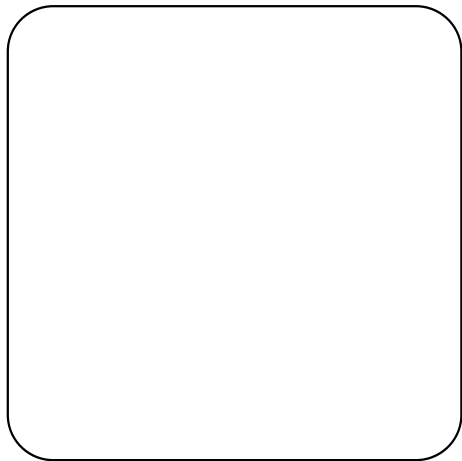

2

glue

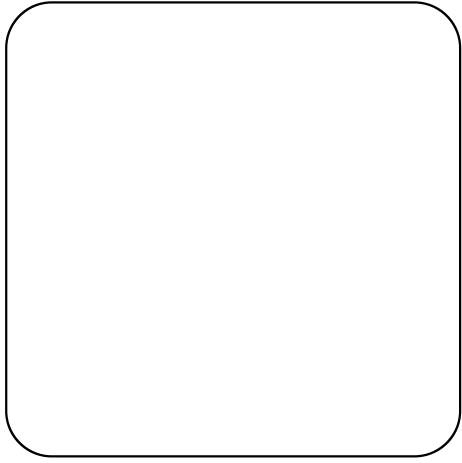

1

pencil

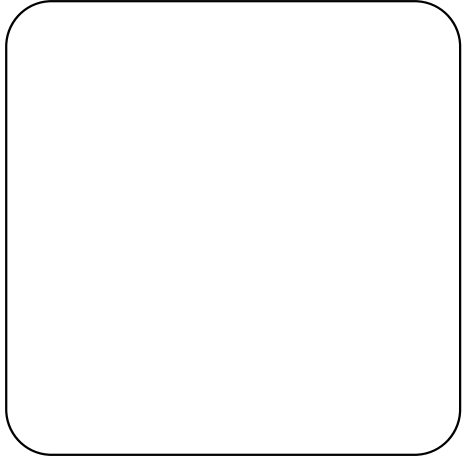

School

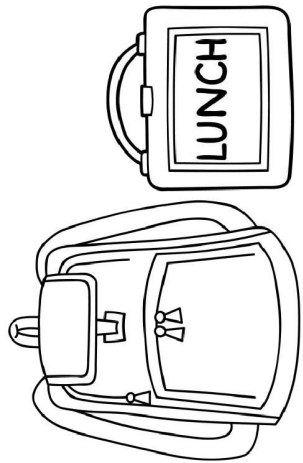

name:

9

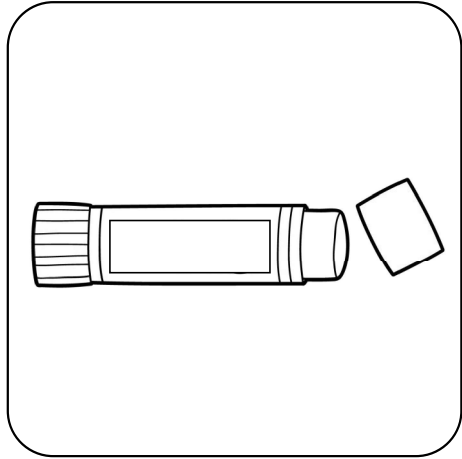

5

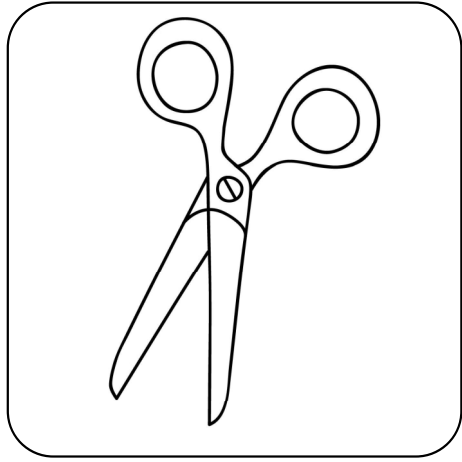

4

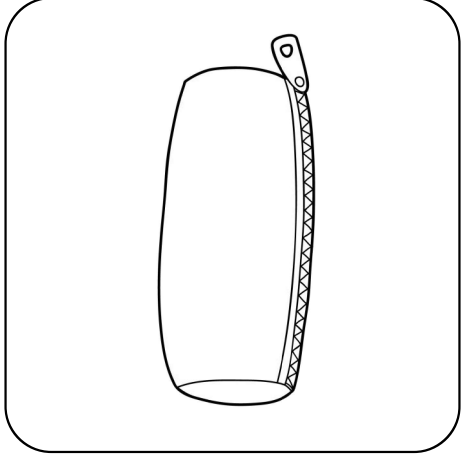

3

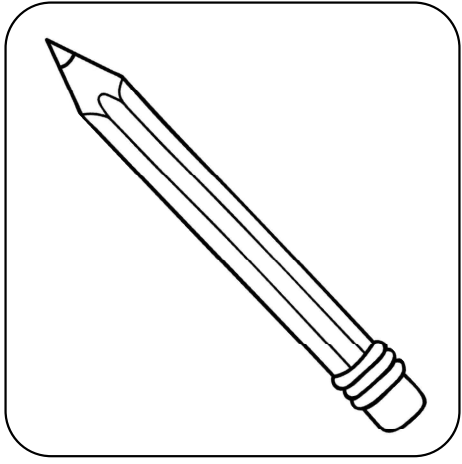

School

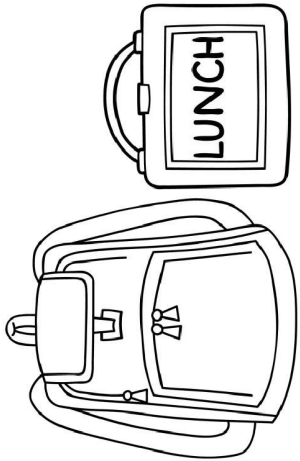

name:

1

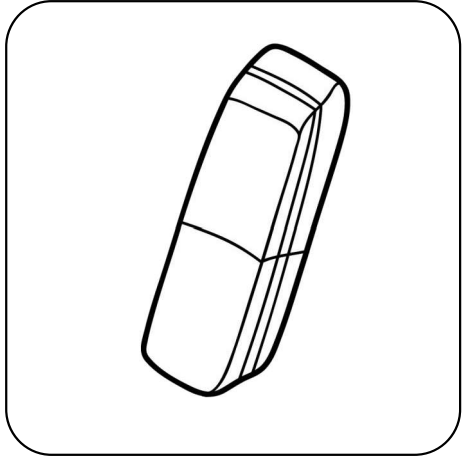

2

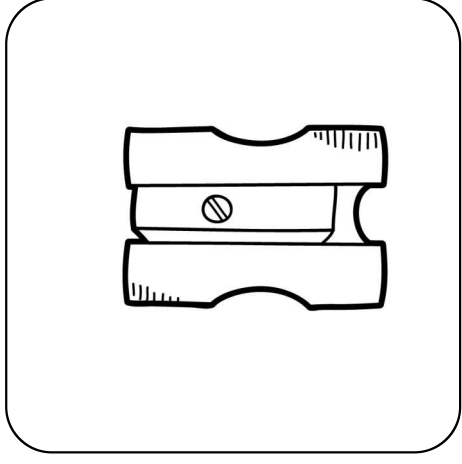

write



school things

name:

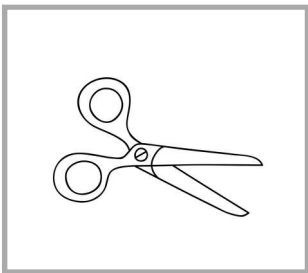

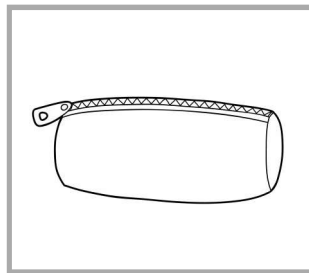

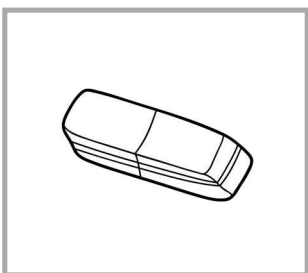

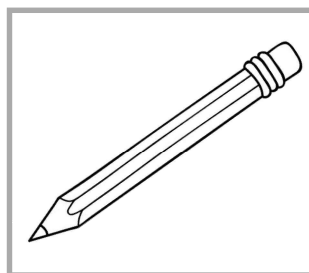

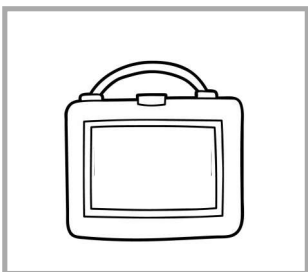

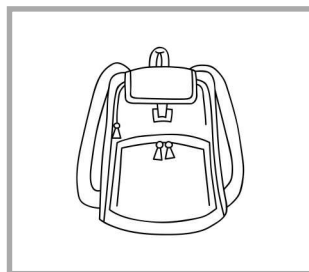

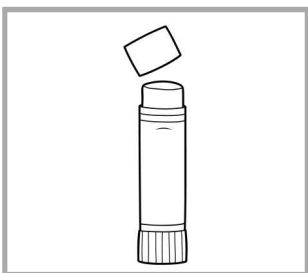

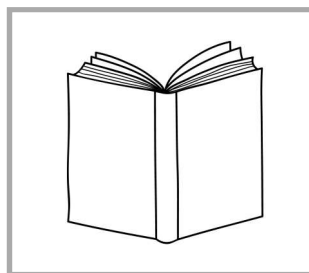

schoolbag • pencil case • glue • lunchbox • rubber • scissors • pencil • book

© www.grundschulchatztruhe.de

Dieses Material ist ausschließlich für schulische Zwecke bestimmt und unterliegt dem deutschen Urheberrecht. Eine kommerzielle Verwendung dieses Materials ist nicht erlaubt. Die Vervielfältigung, Veränderung oder Verbreitung dieses Materials über Soziale Netzwerke, File – Hosting Dienste oder weitere Internetseiten ist nicht gestattet und wird rechtlich verfolgt. Quellenangaben im Material dürfen nicht entfernt werden. Wenn du einen Verstoß gegen diese Richtlinien feststellst, melde diesen bitte an grundschulchatztruhe@gmx.de.

Dieses Material wurde erstellt mit dem Worksheet Crafter www.worksheetcrafter.com

Illustrationen:

Kate Hadfield Designs www.teacherspayteachers.com/Store/Kate-Hadfield-Designs

Worksheet Crafter Premium Cliparts www.worksheetcrafter.com

Pixabay www.pixabay.com

Schrift:

WsC Druckschrift www.worksheetcrafter.com